

SCALE 1/1

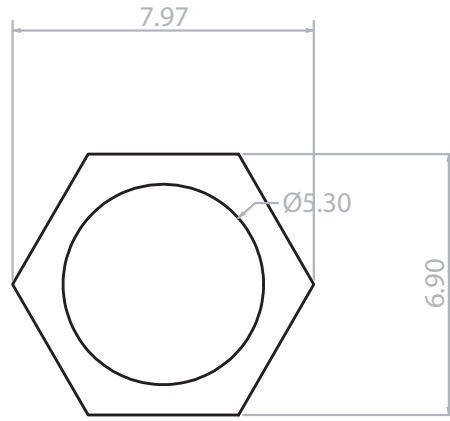

ÖLÇÜ VE ŞEKİL KONTROLÜ YAPILDIKTAN SONRA BÜTÜN SORUMLULUK MÜŞTERİYE AİTTİR.
PROFİL RESMİNDEN DOLAYI OLUŞABİLECEK HATALARDAN PRIME ALÜMİNYUM SORUMLU DEĞİLDİR.

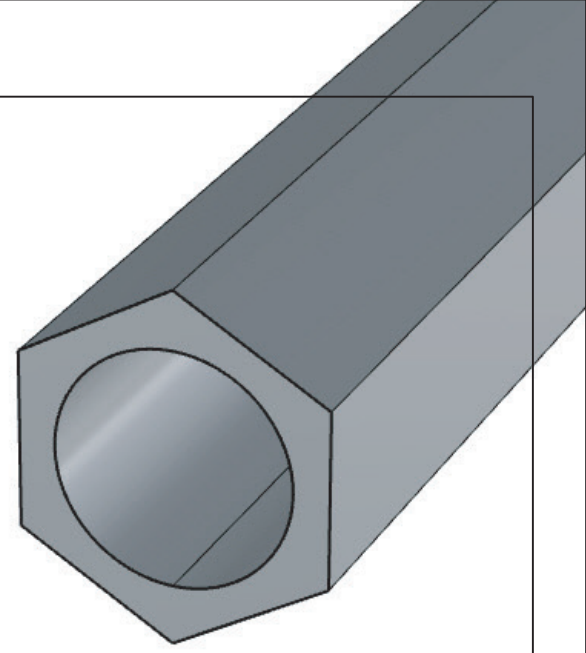

info@aluprime.com
http://www.aluprime.com

PROFİL NO	9584	FİRMA	
ÇEVRE (mm)	23,90	MÜŞTERİ NO	
ALAN (mm ²)	19,17	YAPILIŞ TARİH	
AĞIRLIK (gr/m)	51,95	REV. TARİH	
ALAŞIM	6063-6060	REV. SAYISI	
ÇİZEN	BERİL TAŞOĞLU	TERMİK DEĞERİ	WEBSTER 10-13
KONTROL	KORAL BABACAN	RENK	
KALIP FİR. NO	58696	PRES	1100 TON
Tolerans	TS EN 12020	ÖLÇEK	5:1

Açıklamalar :