

SCALE 1/1

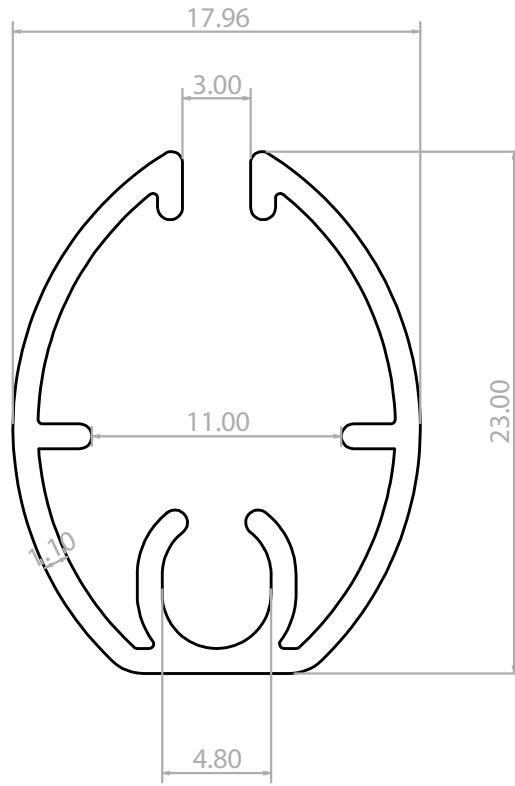

ÖLÇÜ VE ŞEKİL KONTROLÜ YAPILDIKTAN SONRA BÜTÜN SORUMLULUK MÜŞTERİYE AİTTİR.
PROFİL RESMİNDEN DOLAYI OLUŞABİLECEK HATALARDAN PRIME ALÜMİNYUM SORUMLU DEĞİLDİR.

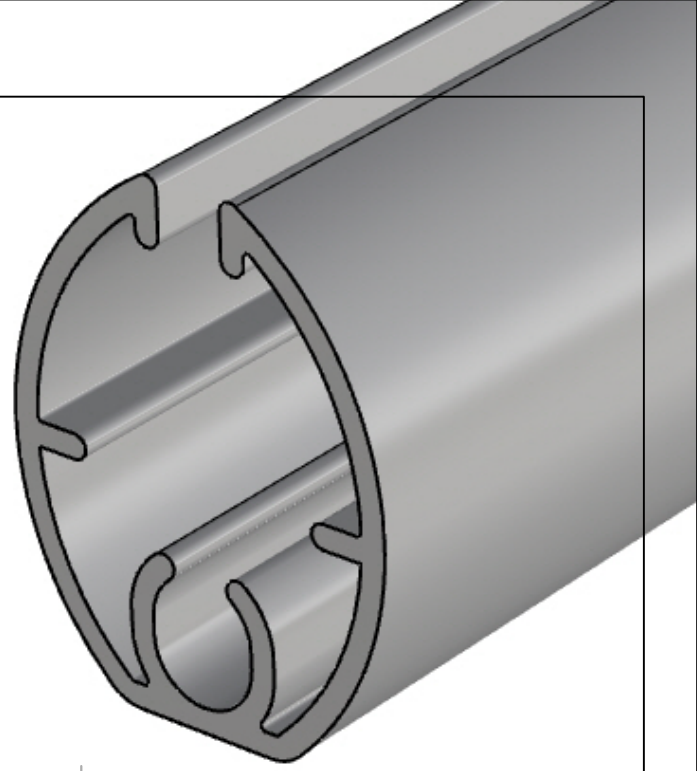
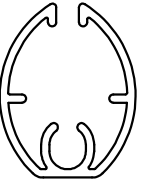

info@aluprime.com
http://www.aluprime.com

PROFİL NO	9564	FİRMA	
ÇEVRE (mm)	157,86	MÜŞTERİ NO	
ALAN (mm ²)	88,83	YAPILIŞ TARİH	
AĞIRLIK (gr/m)	239,84	REV. TARİH	
ALAŞIM	6063-6060	REV. SAYISI	
ÇİZEN	BERİL TAŞOĞLU	TERMİK DEĞERİ	WEBSTER 10-13
KONTROL	KORAL BABACAN	RENK	
KALIP FİR. NO	40328	PRES	1100 TON
Tolerans	TS EN 12020	ÖLÇEK	3/1

Açıklamalar :